



Hook-up Checklist for the Ranger PM7000 (USA)

Step 1. Establish type of installation (e.g. no. of phases).

Step 2. Establish type of transducers (PTs, CTs etc.).

Step 3. Choose one of the ten following hook-up options:

- 1) 3-Phase 4-Wire Wye
- 2) 3-Phase 4-Wire Delta
- 3) Full 3-Phase 3-Wire Delta (3 element for all Ph-Ph)
- 4) 3-Phase 3-Wire Ungrounded (with Equipment Gnd)
- 5) 3-Phase 3-Wire Ungrounded
- 6) 3-Phase 2.5-Element Wye
- 7) 3-Phase 1-Element Wye
- 8) Single Split Phase
- 9) Single Phase
- 10) Uncommitted.

Step 4. Configure instrument for relevant hook-up.

Step 5. Verify physical connections along with instrument LED and PMScreen vector outputs (see pp. 1-10 of these notes).

Step 6. If required, refer to Phase Angle Summary (p. 11).

Step 7. If vectors or LED configurations do not match what is expected or you see the 'Suspect Hook-Up' message, refer to possible explanations and action to be taken (pp. 12-13).



3-Phase 4-Wire Wye

Hook-up as displayed on PMScreen

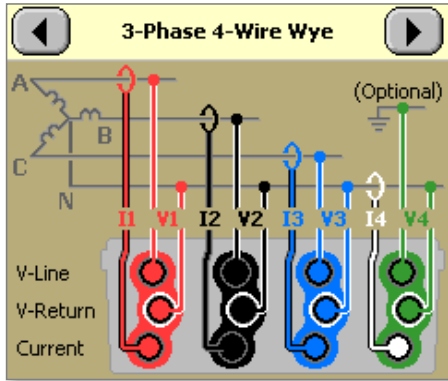

Screenshot from PMScreen

A successful hook-up (based on physical connections and corresponding instrument configuration) is demonstrated via:

- sequentially flashing green LEDs on the top of the instrument
- vector outputs as seen on PMScreen.

Unity Power Factor (PF)

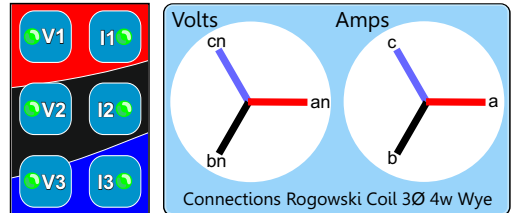

PM 7000 LEDs

Screenshot from PMScreen

Connections are made using:
 4 Rogowski Coils,
 5 Voltage Leads
 with the common Neutral connected
 via 3 link leads (white).



Slightly lagging PF

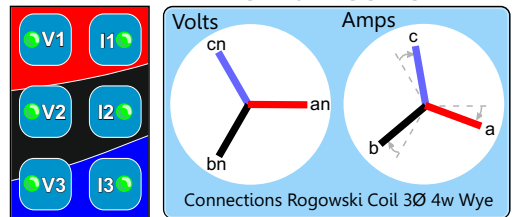

Slightly leading PF

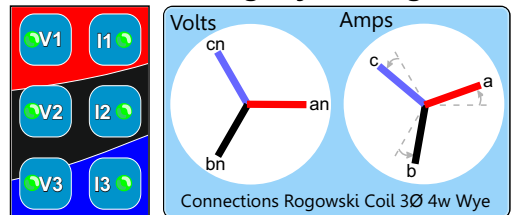

Something not looking right?

See pp. 12 & 13 for possible solutions.

3-Phase 4-Wire Delta

Hook-up as displayed on PMScreen

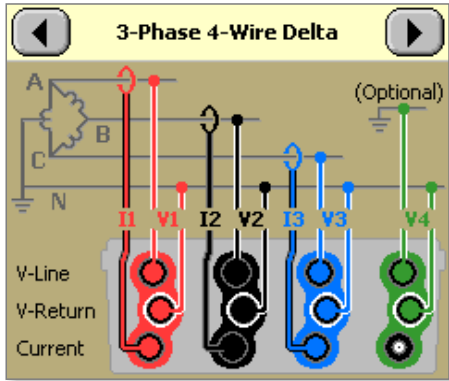

Screenshot from PMScreen

Connections are made using:
3 Rogowski Coils,
5 Voltage Leads
with the common Neutral connected
via 3 link leads (white).



A successful hook-up (based on physical connections and corresponding instrument configuration) is demonstrated here via:

- sequentially flashing green LEDs on the top of the instrument
- vector outputs as seen on PMScreen.

Unity Power Factor (PF)



PM 7000 LEDs

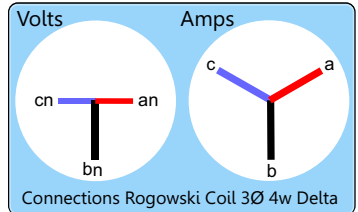

Screenshot from PMScreen

Slightly lagging PF

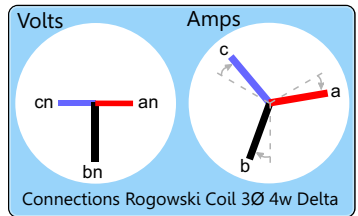

Slightly leading PF

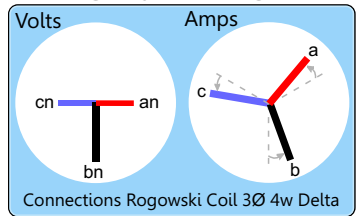

Something not looking right?

See pp. 12 & 13 for possible solutions.

Option: Although not essential it may be useful to connect up the 4th Rogowski coil (blue) as the current could flow along the Neutral.

Full 3-Phase 3-Wire Delta (3 element for all Ph-Ph)

Hook-up as displayed on PMScreen

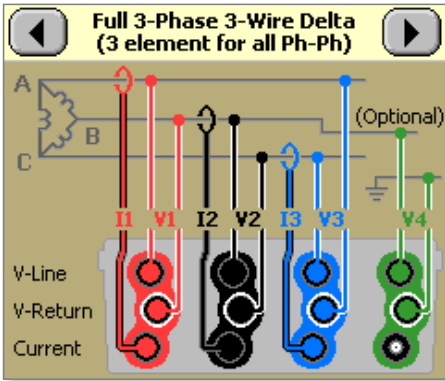

Screenshot from PMScreen

Connections are made using:
 3 Rogowski Coils,
 3 Voltage Leads
 with link leads (white) connecting
 the return though each of the 3 phases.



Something not looking right?

See pp. 12 & 13 for possible solutions.

A successful hook-up (based on physical connections and corresponding instrument configuration) is demonstrated via:

- sequentially flashing green LEDs on the top of the instrument
- vector outputs as seen on PMScreen.

Unity Power Factor (PF)



PM 7000 LEDs

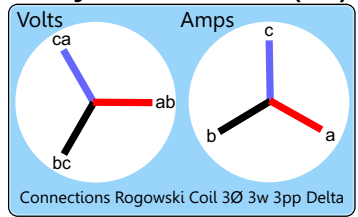

Screenshot from PMScreen

Slightly lagging PF

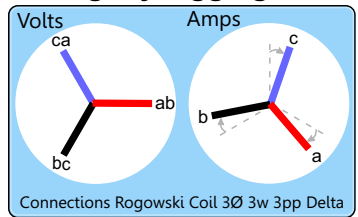

Slightly leading PF

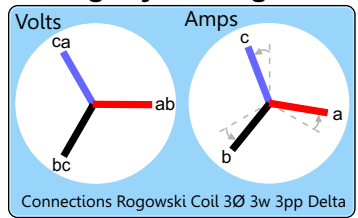

Option: To make use of the 4th voltage channel to measure with respect to earth there are 2 voltage leads left over with which to make the final connection.

e.g. **Blue** = VB = V4 line,
Green = Earth = V4 Return

3-Phase 3-Wire Ungrounded (with Equipment Gnd)

Hook-up as displayed on PMScreen

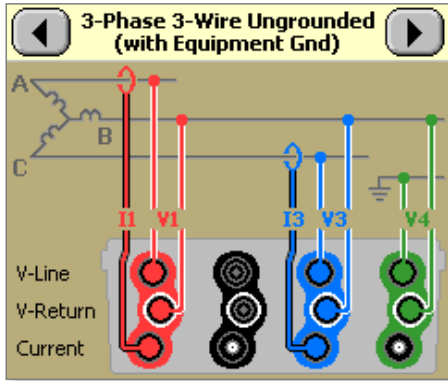

Screenshot from PMScreen

Connections are made using:
 2 Rogowski Coils,
 4 Voltage Leads
 with the return along the B phase
 connected via 2 link leads (white).



A successful hook-up (based on physical connections and corresponding instrument configuration) is demonstrated as follows:

- sequentially flashing green LEDs on the top of the instrument
- vector outputs as seen on PMScreen.

Unity Power Factor (PF)



PM 7000 LEDs

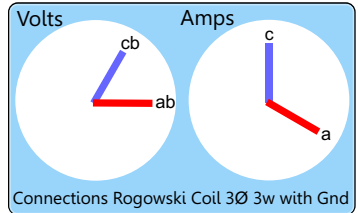

Screenshot from PMScreen

Slightly lagging PF

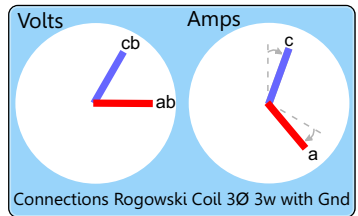

Slightly leading PF

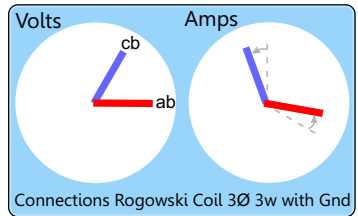

Something not looking right?

See pp. 12 & 13 for possible solutions.

3-Phase 3-Wire Ungrounded

Hook-up as displayed on PMScreen

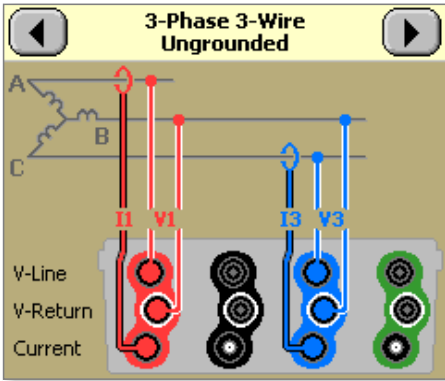

Screenshot from PMScreen

Connections are made using:
 2 Rogowski Coils,
 3 Voltage Leads
 with the return along the B phase
 connected via 1 link lead (white).
 No Earth.



A successful hook-up (based on physical connections and corresponding instrument configuration) is demonstrated here:

- sequentially flashing green LEDs on the top of the instrument
- vector outputs as seen on PMScreen.

Unity Power Factor (PF)



PM 7000 LEDs

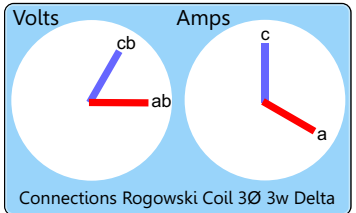

Screenshot from PMScreen

Slightly lagging PF

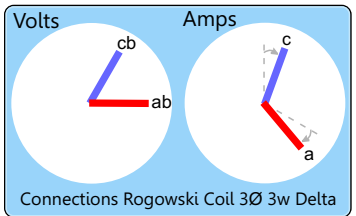

Slightly leading PF

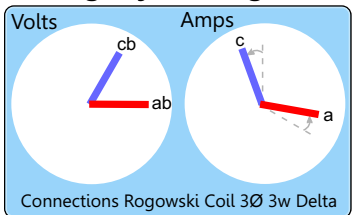

Something not looking right?

See pp. 12 & 13 for possible solutions.

3-Phase 2.5-Element Wye

Hook-up as displayed on PMScreen

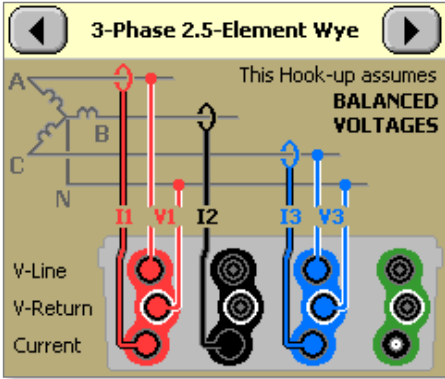

Screenshot from PMScreen

Connections are made using:
3 Rogowski Coils,
3 Voltage Leads
with the common Neutral connected
via 1 link lead (white).



A successful hook-up (based on physical connections and corresponding instrument configuration) is demonstrated as follows:

- sequentially flashing green LEDs on the top of the instrument
- vector outputs as seen on PMScreen.

Unity Power Factor (PF)



PM 7000 LEDs

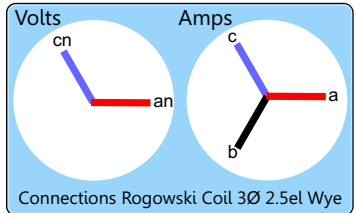

Screenshot from PMScreen

Slightly lagging PF

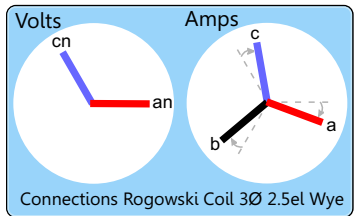

Slightly leading PF

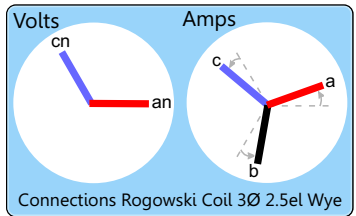

Something not looking right?

See pp. 12 & 13 for possible solutions.

3-Phase 1-Element Wye

Hook-up as displayed on PMScreen

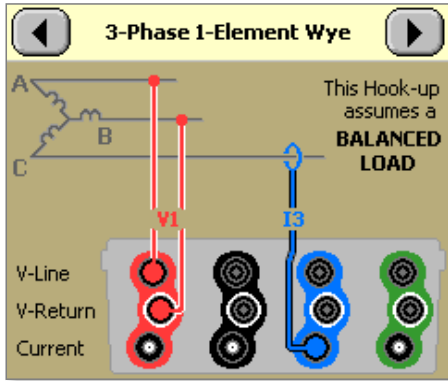

Screenshot from PMScreen

Connections are made using:
 1 Rogowski Coil,
 2 Voltage Leads
 with the return along the B phase



A successful hook-up (based on physical connections and corresponding instrument configuration) is demonstrated via:

- sequentially flashing green LEDs on the top of the instrument
- vector outputs as seen on PMScreen.

Unity Power Factor (PF)



PM 7000 LEDs

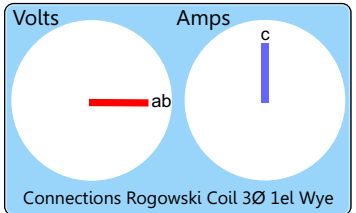

Screenshot from PMScreen

Slightly lagging PF

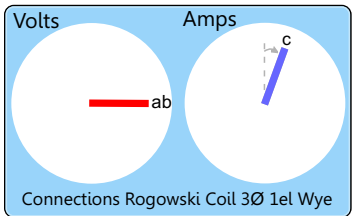

Slightly leading PF

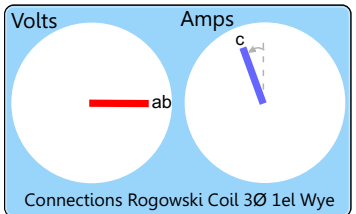

Something not looking right?

See pp. 12 & 13 for possible solutions.

Single (Split) Phase

Hook-up as displayed on PMScreen

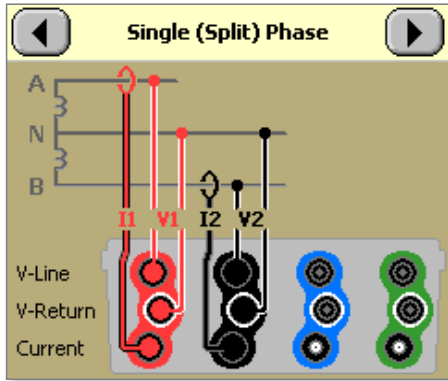

Screenshot from PMScreen

Connections are made using:
 2 Rogowski Coils,
 3 Voltage Leads
 with the common Neutral connected
 via 1 link lead (white).



A successful hook-up (based on physical connections and corresponding instrument configuration) is demonstrated here:

- sequentially flashing green LEDs on the top of the instrument
- vector outputs as seen on PMScreen.



PM 7000 LEDs

Unity Power Factor (PF)

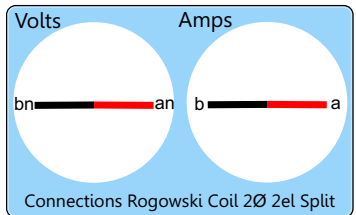

Screenshot from PMScreen

Slightly lagging PF

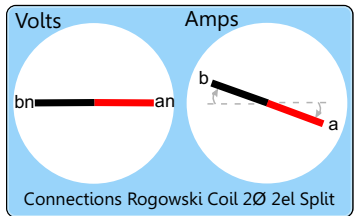

Slightly leading PF

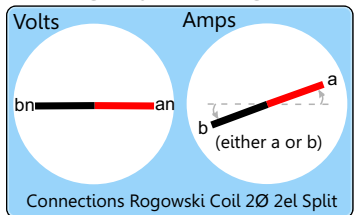

Something not looking right?

See pp. 12 & 13 for possible solutions.

Single Phase

Hook-up as displayed on PMScreen

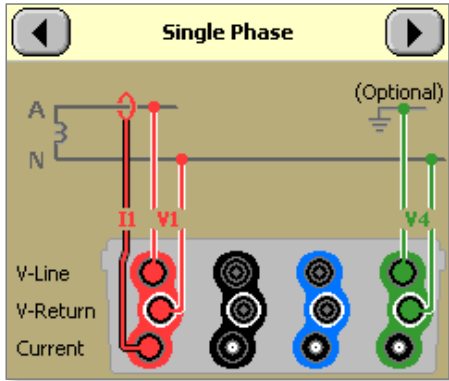

Screenshot from PMScreen

Connections are made using:
 1 Rogowski Coil,
 3 Voltage Leads
 with the common Neutral connected
 via 1 link lead (white).



A successful hook-up (based on physical connections and corresponding instrument configuration) is demonstrated as follows:

- sequentially flashing green LEDs on the top of the instrument
- vector outputs as seen on PMScreen.

Unity Power Factor (PF)



PM 7000 LEDs

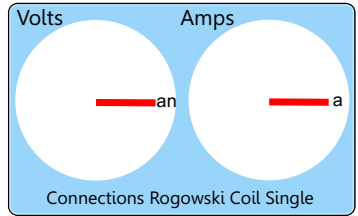

Screenshot from PMScreen

Slightly lagging PF

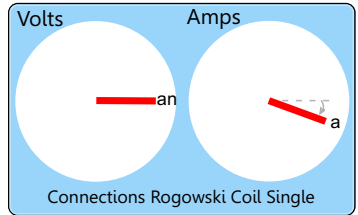

Slightly leading PF

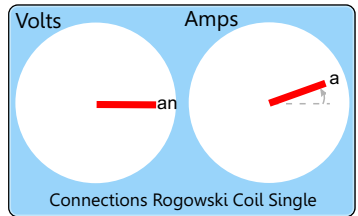

Something not looking right?

See pp. 12 & 13 for possible solutions.

Uncommitted

Hook-up as displayed on PMScreen

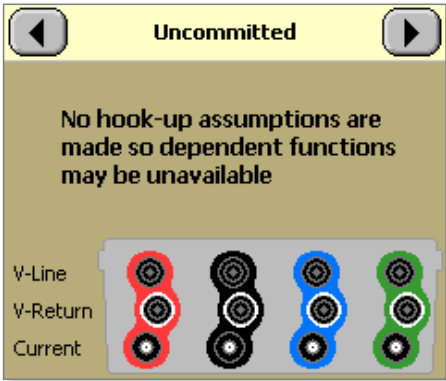

Screenshot from PMScreen

A successful hook-up (based on physical connections and corresponding instrument configuration) is demonstrated via:

- sequentially flashing green LEDs on the top of the instrument
- vector outputs as seen on PMScreen.

Unity Power Factor (PF)

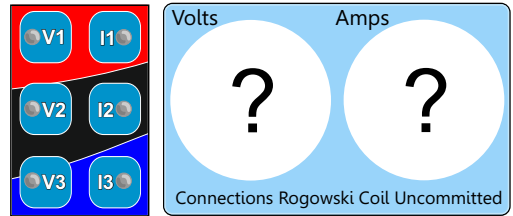

PM 7000 LEDs

Screenshot from PMScreen

You can use whichever connections are required.

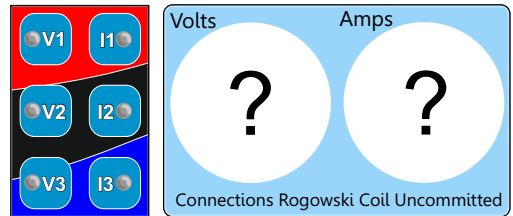
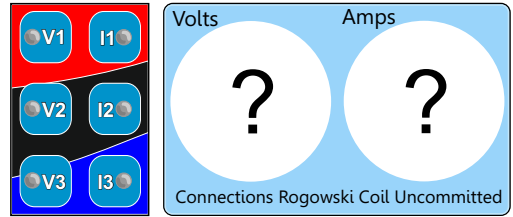

Phase Angle Summary

Expected phase angles are with respect to the reference vector of ChV1

Hook-Up Description		V1	V2	V3	I1	I2	I3
1	3-Phase 4-Wire Wye	0°	240°	120°	0°	240°	120°
2	3-Phase 4-Wire Delta	0°	-90°	180°	30°	-90°	150°
3	Full 3-Phase 3-Wire Delta (3 element for all Ph-Ph)	0°	240°	120°	-30°	210°	90°
4	3-Phase 3-Wire Ungrounded (with Equipment Gnd)	0°		60°	-30°		90°
5	3-Phase 3-Wire Ungrounded	0°		60°	-30°		90°
6	3-Phase 2.5-Element Wye	0°		120°	0°	240°	120°
7	3-Phase 1-Element Wye	0°					90°
8	Single Split Phase	0°	180°		0°	180°	
9	Single Phase	0°			0°		
10	Uncommitted	?	?	?	?	?	?

Voltage Tolerances

Phase angle wrt expected	Hook-Up	LED on top of instrument
$0 \pm 10^\circ$	Good	Green
$180 \pm 10^\circ$	Reversed	Red
All else	Suspect	Orange

Current Tolerances

Phase angle wrt expected	Hook-Up	LED on top of instrument
$0 \pm 45^\circ$	Good	Green
$180 \pm 45^\circ$	Reversed	Red
All else	Suspect	Orange

If “Suspect Hook-Up” shows, click on the PMScreen vector diagram where it will show the hook-up that the instrument is anticipating. Click on  for specific information and advice.

It is possible at this point to reverse the current phases by clicking . This is recommended for correction only when manual reversal is not possible.

Example Errors & Possible Explanations: Vectors

Examples made using a 3-Phase 3-Wire Ungrounded Circuit

EXPECTED	WHAT YOU SEE	EXPLANATION & SOLUTION
<p>Unity Power Factor (PF)</p> <p>Connections Rogowski Coil 3Ø 3w Delta</p>	<p>Unity Power Factor (PF)</p> <p>Suspect Hook-Up</p> <p>Connections Rogowski Coil 3Ø 3w Delta</p>	<p>The CTs are on the wrong phases. Swap the CTs around to align voltage and current Phasing.</p>
<p>Unity Power Factor (PF)</p> <p>Connections Rogowski Coil 3Ø 3w Delta</p>	<p>Unity Power Factor (PF)</p> <p>LOW SIGNAL</p> <p>Connections Rogowski Coil 3Ø 3w Delta</p>	<p>The CB voltage phase has a bad connection. Try reconnecting.</p>
<p>Unity Power Factor (PF)</p> <p>Connections Rogowski Coil 3Ø 3w Delta</p>	<p>Severely Lagging PF</p> <p>Suspect Hook-Up</p> <p>Connections Rogowski Coil 3Ø 3w Delta</p>	<p>Power Factor is severely lagging (beyond 45°). “Suspect Hook-Up” message displayed. THIS MAY BE CORRECT so no solution needed.</p>
<p>Slightly lagging PF</p> <p>Connections Rogowski Coil 3Ø 3w Delta</p>	<p>Slightly lagging PF</p> <p>Suspect Hook-Up</p> <p>Connections Rogowski Coil 3Ø 3w Delta</p>	<p>Power Factor is lagging and both CTs are reversed. Turn round the CTs to face them in the correct direction.</p>

For further information and advice in PMScreen click on the vector diagram (which brings up the hook-up the instrument has been set up for) and then on [Details](#).

Example Errors & Possible Explanations: LEDs

Examples made using a 3-Phase 3-Wire Ungrounded Circuit

EXPECTED

WHAT YOU SEE

EXPLANATION & SOLUTION



No signal received by CB phase voltage lead. Check connection.

Current phase A is probably reversed. Try changing it round.

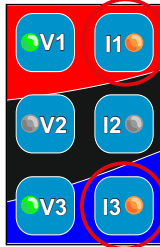

Current phases A & C may be swapped over OR possibly have very bad Power Factor due to excessive lagging current. In the latter case the phases may be correct.

If necessary try swapping CTs over. Refer to Vector diagrams if unsure.